

# YT24064 图形点阵液晶显示模块 使用说明书

---

感谢您关注和使用我们的点阵系列液晶显示器产品，欢迎您提出您的要求、意见和建议，我们将竭诚为您服务、让您满意。

## 1、 概述

YTYT24064 是一种图形点阵液晶显示器，它主要由行驱动器/列驱动器及 240\*64 全点阵液晶显示器组成。可完成图形显示，也可以显示 15×4 个（16×16 点阵）汉字。

主要技术参数和性能：模块内自带负压，用于 LCD 的驱动电压

- 1、电源 VDD: +5V;
- 2、显示内容: 240 (列) × 64 (行) 点
- 3、全屏幕点阵
- 4、十三种指令
- 5、与 CPU 接口采用 8 位数据总线并行输入输出
- 6、驱动路数 1/64
- 7、工作温度: 0° C ~ +55° C, 存储温度: -20° C ~ +70° C

## 2、 外形尺寸



图 1: YT24064 模块尺寸图

### 3、 模块主要硬件构成说明 (结构框图)

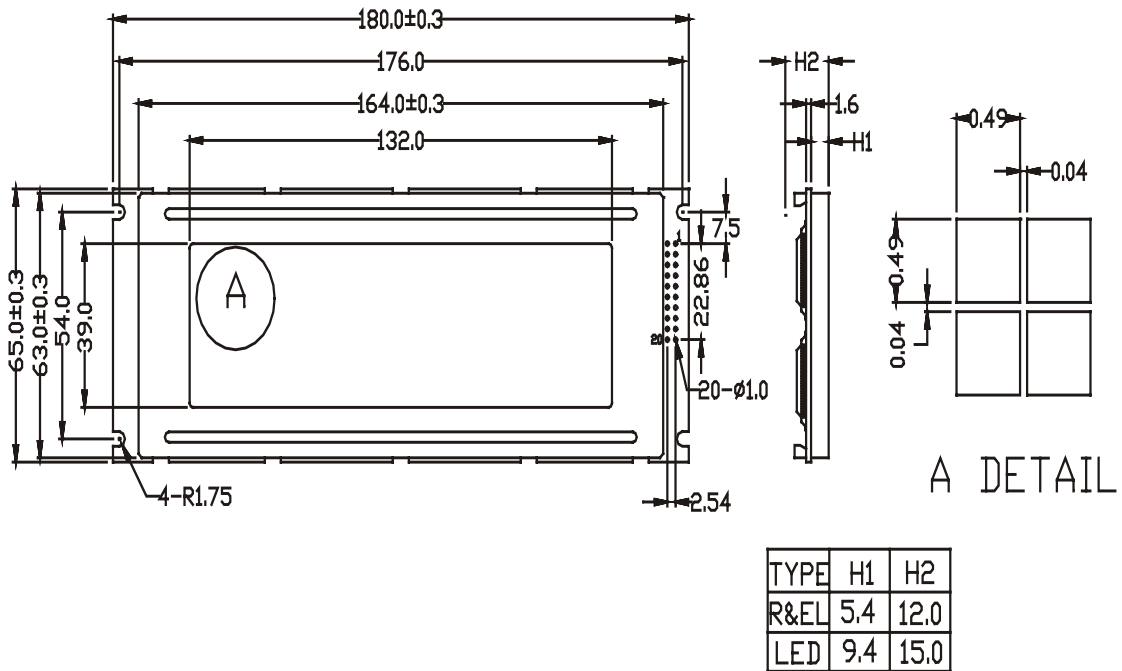
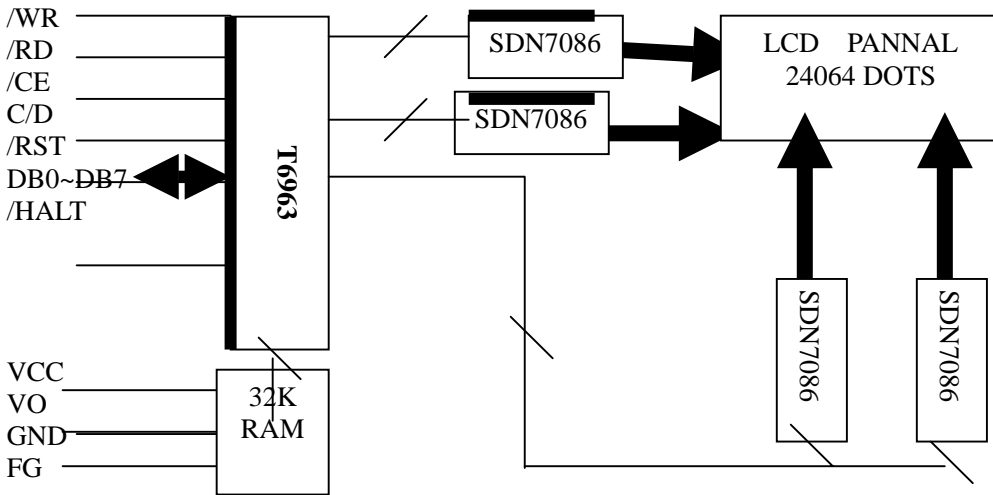

### 4 Absolute Mazimum Ratingsed

Item	Symbol	Min.	Max	Unit	Remark
Power Supply Voltage	VDD-VSS	0	7.0	V	
LCD Driving Voltage	VDD-VEE	--	18.0		
Operating Temperature Range	Top	-20	70	° C	NO Condensation
Storage Temperature Range	Tst	-30	80		

### 5 Electrical Specifications and Instruction Code

#### 5.1 Electrical Characteristics

Item	Symbol	Min	Typ	Max	Unit	Remark
Supply Voltage(logic)	VDD-VSS	4.5	5.0	5.5	V	
Supply Voltage(LCD Drive)	VSS-VEE	---	6.0	---	V	
Input Signal Voltage	“H”Level	VIN	VDD-2.2	---	VDD	V
	“L”Level	VIL	0	---	0.8	V
Supply current(logic)	IDO	---	24	---	MA	
Supply rrent(LCD Drive)	IEE	---	2.0	---	MA	

### 6 模块的外部接口

外部接口信号如下表 2 所示:

编号	符号	引脚说明	编号	符号	引脚说明
1	FG	构造地	12	D1	Data1
2	VSS	电源地	13	D2	Data2

3	VDD	电源正极 (+5V)	14	D3	Data3
4	VO	液晶显示偏压信号	15	D4	Data4
5	WR	写信号	16	D5	Data5
6	RD	读信号	17	D6	Data6
7	CE	使能信号	18	D7	Data7
8	C/D	数据/命令选择端 (H/L)	19	FS	Font selection
9	NC/ LED+/ VEE/	NC/ LED+/ LCD 驱动负电压输出	20	NC VEE/ LED+	NC LCD 驱动负电压输出 /LED+
10	/RST	复位端 (L 有效)	21	A	背光源正极 (5V)
11	D0	Data0	22	K	背光源负极 (+V)

备注: 产品出厂 9 脚和 20 脚为空脚。可根据客户需要调整 9 脚与 20 脚为 VEE 或者为 LED+。通过跳接可以交换 9 脚和 20 脚的功能使用。LED 可通过 2, 3 脚直接点亮

接口时序:

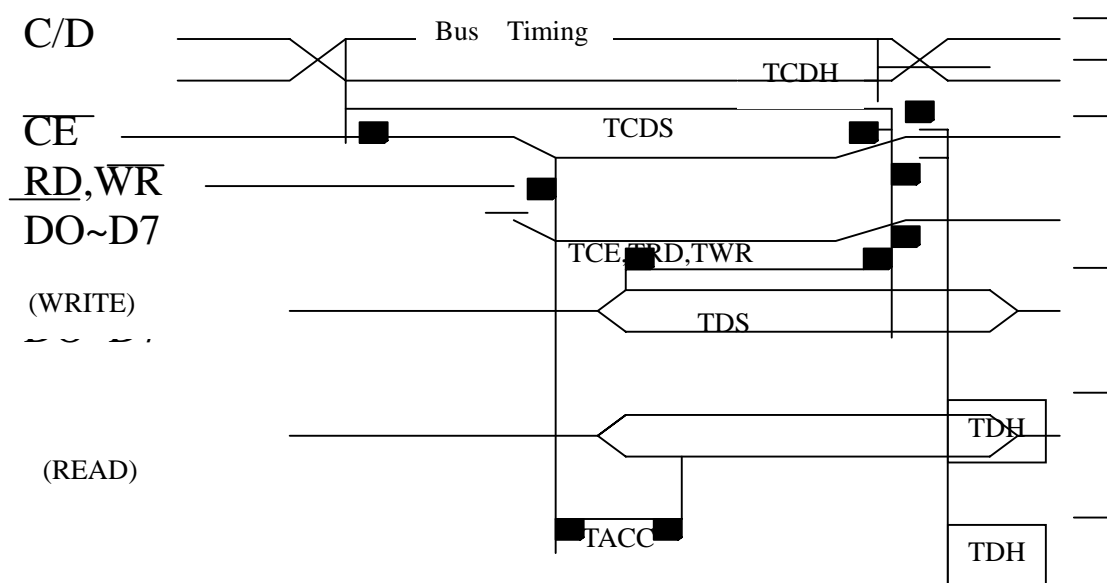

Unless otherwise specified, VDD=5.0±10%, VSS=0V, Ta=-10~70° C

Item	Symbol	Test Condition	MIN	MAX	UNIT
C/D Set up Time	TCDS		100	--	NS
C/D Hold Time	TCDH		10	--	NS
CE, RD, WR Width	TCE, TRD, TWR		80	--	NS
Data Set up Time	TDS		80	--	NS
Data Hold Time	TDH		40	--	NS
Access Time	TACC		--	150	NS
Output Hold Time	TOH		10	50	NS

## 7、指令说明

命令	代码	D1	D2	功能
地址指针 设置	00100001 00100010 00100100	水平位 置 偏置地 址 低字节	垂直位 置 00H 高字节	光标地址设置 CGRAM 偏置地址设置 显示地址设置
显示区域 设置	01000000 01000001 01000010 01000011	低字节 字节数 低字节 字节数	高字节 00H 高字节 00H	文本显示区首地址 文本显示区宽度 图形显示区首地址 图形显示区宽度
显示方式 设置	1000x000 1000x001 1000x011 1000x100 1000xxx 10001xxx	-- -- -- -- -- --	-- -- -- -- -- --	逻辑“或” 逻辑“异或” 逻辑“与” 文本属性 启用内部 CGROM 启外部 CGROM
显示状态 设置	10010000 1001xx10 1001xx11 100101xx 100110xx 100111xx	-- -- -- -- -- --	-- -- -- -- -- --	关显示 启用光标显示, 禁用光标闪烁 启用光标显示, 启用光标闪烁 启用文本显示, 禁用图形显示 禁用文本显示, 启用图形显示 启用文本显示, 启用图形显示
光标形状 设置	10100000 10100001 10100010 10100011 10100100 10100101 10100110 10100111	-- -- -- -- -- -- -- --	-- -- -- -- -- -- -- --	一行 二行 三行 四行 五行 六行 七行 八行
数据自动 读写设置	10110000 10110001 1011001X	-- -- --	-- -- --	启用自动写方式 启用自动读方式 禁用自动读方式
数据(一次) 读写设置	11000000 11000001 11000010 11000011 11000100 11000101	-- -- -- -- -- --	-- -- -- -- -- --	数据写, 地址加一 数据读, 地址加一 数据写, 地址减一 数据读, 地址减一 数据写, 地址不变 数据读, 地址不变
屏读(一字节)设置	11100000	--	--	启用屏读
屏拷贝(一行)设置	11101000	--	--	启用屏拷
位操作	11110xxx 11111xxx 1111x000 1111x001 1111x010 1111x011 1111x100 1111x101 1111x110 1111x111	-- -- -- -- -- -- -- -- -- --	-- -- -- -- -- -- -- -- -- --	位清“0” 位置“1” 0位(低位) 1位 2位 3位 4位 5位 6位 7位(高位)

CGROM 字符库

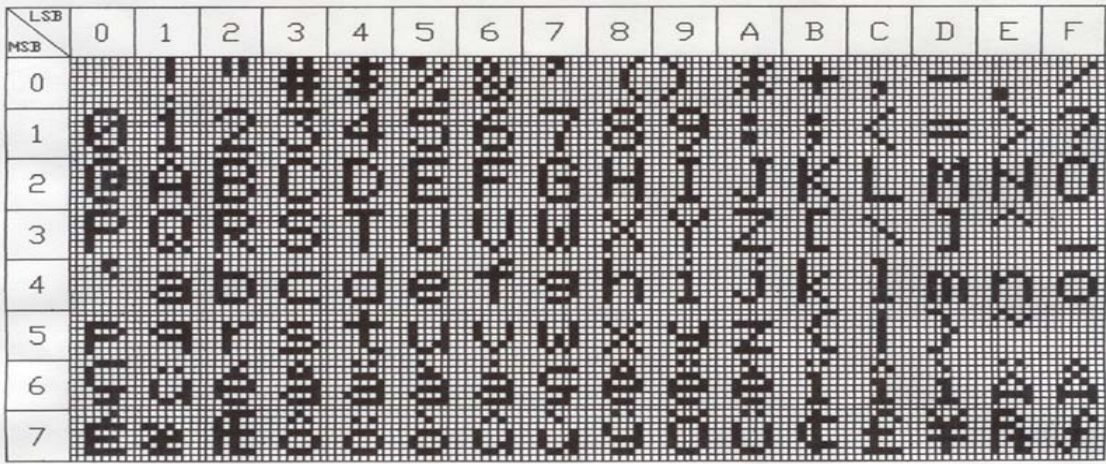

8、光学特性

8.1 光学特性 Ta=25° C

项目	符号	测试条件	最小值	典型	最大值	单位	备注
视角	$\ominus x$	CR >3	$\ominus y=0$	-20	----	20	DEG
	$\ominus y$		$\ominus x=0$	-25	----	-25	
对比度	CR	$\ominus x=0^\circ$ $\ominus y=15^\circ$	3				
响应时间	Turn on	Ton	$\ominus x=0^\circ$			200	MS
	Turn off	Toff	$\ominus y=0^\circ$			360	

8.2 光学特性

8.2.1 光学特性 Ta=25° C

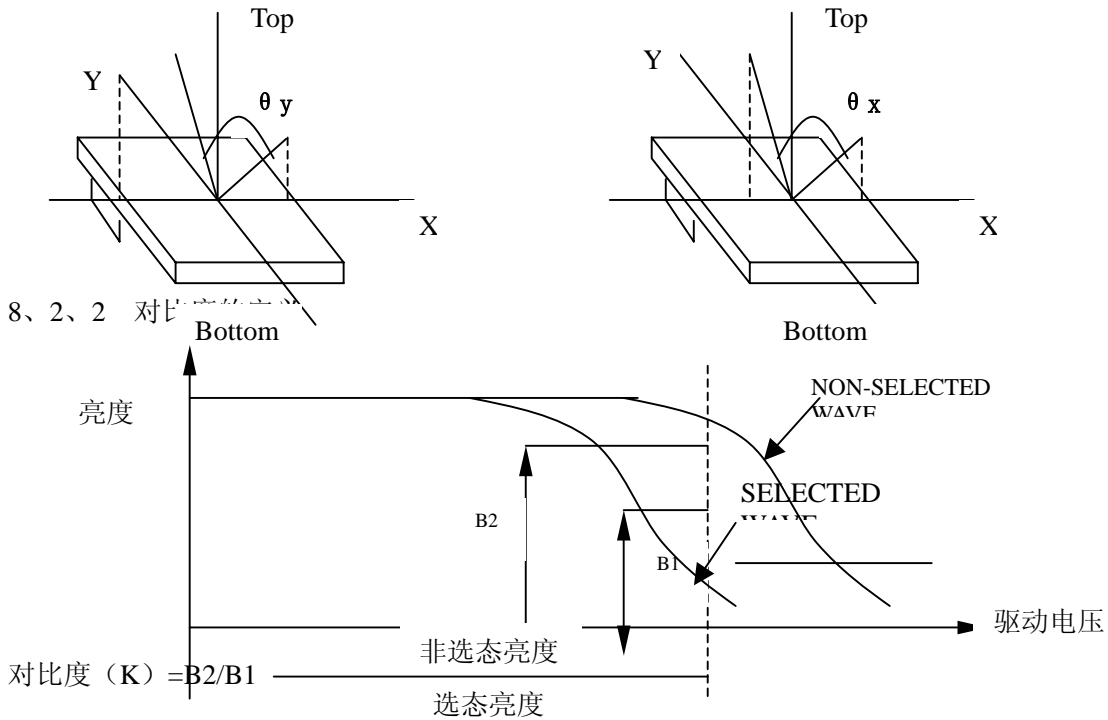

测量条件

- 1) 环境温度: 25° C; 2) 测试频率: 32Hz

8、2、响应时间（如下图）

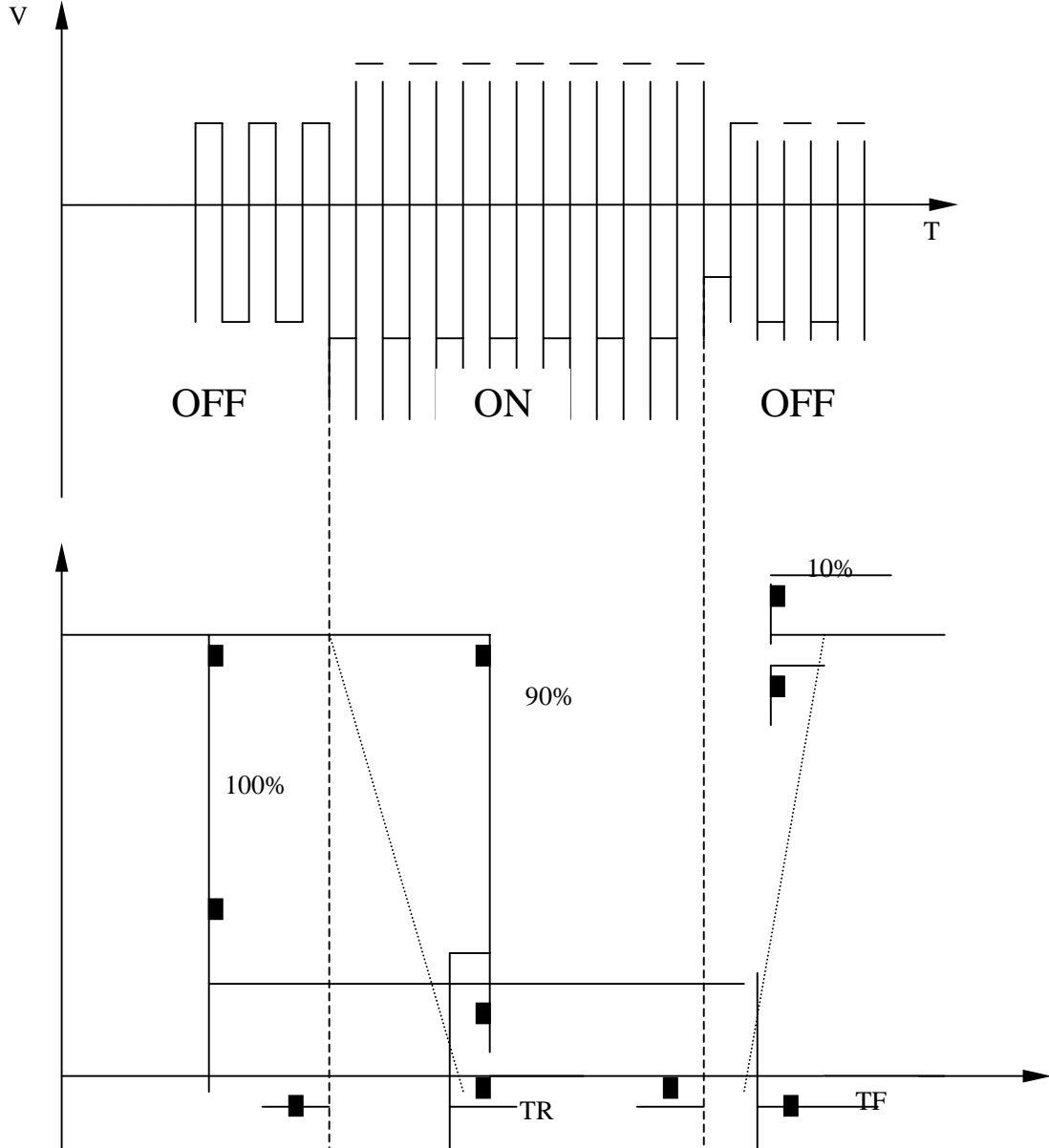

9、环境特性

9.1 Content of Reliability Test

NO.	Test Item	Content of Test	Test condition
1	High Temperature Storage	Endurance test applying the high storage temperature for a long time	60° C 96H
2	Low Temperature Storage	Endurance test applying the low storage temperature for a long time	50° C 96H
3	High Temperature Operation	Endurance test applying the Temperature electric stress(voltage&current) and the thermal stress to the element for along time	50° C 96H
4	High Temperature Operation	Endurance test applying the Temperature electric stress(voltage&current) and the thermal stress to the element for along time	0° C 96H

5	High Temperature /Humidity Storage	Endurance test applying the high temperature and high humidity storage for a long time	40° C 90%RH 96H
6	Temperature Cycle	Endurance test applying the low and high temperature cycle 10 cycle-20° C--25° C--60° C--25° C <u>30min 5min 30min 5min</u> 1cycle	-20° C/60° C
7	Vibration Test (package state)	Endurance test applying the vibration during transportation	10Hz~55Hz~10Hz 1.5mmP-P,1.5g X.Y.-5mm
8	Shock Test (package state)	Endurance test applying the shock during transportation	Drop a product form a height of 79cm to a solid unbending and horizontal plane
9	Atmospheric Pressure Test	Endurance test applying the atmospheric prssure during transportation by air	40kPa 24H

## 9.2 Failure Judgment Criterion

Criterion Item	Test Item NO.									Failure Judgement Criterion
	1	2	3	4	5	6	7	8	9	
Basic Specification	0	0	0	0	0	0	0	0	0	Out of ghe basic Specification
Elestrical Specification	0	0	0	0	0					Out of the electrical specification
Mechanical Specification						0	0	0	0	Out of the mchanical specification
Optical Characteristic	0	0	0	0	0	0				Out of the optical specification
Remark	Basic specification=Display specification+Mechanical specification									



## 10. 使用注意事项

### 10、1 Handling Precautions

- 10、1、1 The display panel is made of glass .Do not subject it to a mechanical shock by dropping it from a high place ,etc.
- 10、1、2 If the display panel is damaged and the liquid crystal substance inside it leaks out,be sure not to get any in your mouth,if the substance comes into contact with your skyn or clothes,promptly wash it off using soap and water.
- 10、1、3 Do not apply excessive force to the display surface or the adjoining areas since this may cause the color tone to vary.
- 10、1、4 The polarizer covering the display surface of the LCD module is soft and easily scratched.Handle this polarizer carefully.
- 10、1、5 If the display surface become contaminated,breathe on the surface and gently wipe it with a soft dry cloth.if still not completely clear,moisten cloth with one of the lollowing solvents:  
 -----Isopropyl alcohol  
 -----Ethyl alcohol  
 Solvents other than those mentioned above may damage the Polarizer.Especially,see the following:  
 -----Water  
 -----Ketone  
 -----Aromatic solvents
- 10、1、6 Do not attempt to disassemble the LCD Module
- 10、1、7 NC terminal should be open.do not connect anything
- 10、1、8 If the logic circuit power is off,do not apply the input signals
- 10、1、9 Ta prevent destruction of the elements by electricity ,be careful to maintain an optimum work environment
- Be sure to ground the body when handling the LCD Modules
  - Tools required for assembly,such as soldering
  - Irons,must be properly ground
  - To reduce the amount of static electricity generated do not conduct assembly and other work under dry conditions.
  - The LCD Module is coated with a film to protect the display surface.Be care when peeling off this protective film since static electricity may be generated.

## 11. 应用例子

自动写子程序:

```
AUTO_WR:  LCALL  RD_STA           ;用 LCM_DATA 自动写数据
           JNB ACC. 3, AUTO_WR
           CLR LCM_CD
           SETB  LCM_RD
           MOV A, LCM_DATA
           MOV P0, A
           CLR LCM_WR
           NOP
           SETB  LCM_WR
           RET
```

写指令子程序:

---

```
SEND_I:   LCALL  RD_STA           ;用 LCM_CMD 写命令
          JNB ACC. 0, SEND_I
          JNB ACC. 1, SEND_I
          SETB   LCM_CD
          SETB   LCM_RD
          MOV A, LCM_CMD
          MOV P0, A
          CLR LCM_WR
          NOP
          SETB   LCM_WR
          RET
```

写数据子程序:

```
SEND_D:   LCALL  RD_STA           ;用 LCM_DATA 写数据
          JNB ACC. 0, SEND_D
          JNB ACC. 1, SEND_D
          CLR LCM_CD
          SETB   LCM_RD
          MOV A, LCM_DATA
          MOV P0, A
          CLR LCM_WR
          NOP
          SETB   LCM_WR
          RET
```

读状态子程序

```
RD_STA:   MOV P0, #0FFH
          SETB   LCM_CD
          SETB   LCM_WR
          CLR LCM_RD           ;START READ
          NOP
          MOV A, P0
          SETB   LCM_RD           ;END READ
          RET
```